

Product Information Motor-driven Diaphragm Dosing Pump MEMDOS LB

Reliable dosing of chemicals

Motor-driven diaphragm dosing pumps play an important role in the reliable and accurate dosing of liquids in process cycles. They are appropriate for low-pressure applications and high dosing quantities.

Dosing pumps are used in many branches of industry that work with liquid chemicals - not excluding toxic and highly-aggressive media.

Riding on the crest of the waves

Two sizes of the MEMDOS LB series are available. A large coverage in terms of performance and resistance is available, thanks to the variety of dosing heads, combined with a wide range of dosing head materials.

The performance ranges from 0 – 4 up to 0 – 150 l/h for the first size, and 0 – 110 up to 0 to 1010 l/h for the second size. The maximum permitted pressure, depending on the size, is between 4 and 16 bar.

Thanks to the sturdy tappet drive with manual or automatic capacity adjustment, the conveyed media such as acids, lyes, coagulants and flocculants are dosed reliably and precisely.

On request, the MEMDOS LB pumps can also be supplied with a double-diaphragm system. Then uncontrolled leakage of media is avoided even if the dosing diaphragm wears out.

Versatile and flexible

The MEMDOS LB is used when the integration of the pump into controls or control circuits is required.

For constant dosing without a controller, the motor of MEMDOS LB is directly connected to the terminal box. A great variety of three-phase and single-phase motors is available for this purpose.

To adapt the dosing capacity, either the stroke length can be adjusted mechanically or the speed of the three-phase motor can be regulated by means of a separate frequency converter.

In Short

- Capacity range 4 to 1010 l/h, up to 16 bar
- Minor dependence of the backpressure
- Infinitely variable stroke frequency from 0 to 100%
- Tappet drive with manual and automatic capacity adjustment
- Materials available: PVC, PP, PVDF and stainless steel
- Compact design, low space requirement
- Non-leaking
- Material consistency for the pumps and accessories
- A variety of three-phase and single-phase motors are available
- Double-diaphragm system (optional)
- ATEX versions for Zones 1 and 2 are available
- Also suitable for frequency converter operation



Model variants

MEMDOS	Material			
	PVC	PP	PVDF	Stainless steel
LB 4	10407017	10407001	10407033	10407049
LB 4-HP	10407068	10407065	10407071	10407074
LB 10	10407018	10407002	10407034	10407050*
LB 10-HP	10407069	10407066	10407072	10407075
LB 20	10407019	10407003	10407035	10407051
LB 20-HP	10407070	10407067	10407073	10407076
LB 35	10407020	10407004	10407036	10407052
LB 60	10407021	10407005	10407037	10407053
LB 80	10407022	10407006	10407038	10407054
LB 150	10407023	10407007	10407039	10407055
LB 110	10407024	10407008	10407040	10407056
LB 160	10407025	10407009	10407041	10407057
LB 210	10407026	10407010	10407042	10407058
LB 260	10407027	10407011	10407043	10407059*
LB 310	10407028	10407012	10407044	10407060
LB 400	10407029	10407013	10407045	10407061
LB 510	10407030	10407014	10407046	10407062
LB 760	10407031	10407015	10407047	10407063
LB 1010	10407032	10407016	10407048	10407064

*) Also available in an ATEX version

Technical data

MEMDOS LB			4	4-HP	10	10-HP	20	20-HP	35	60	80	150	
Delivery capacity at max. pressure	50 Hz	l/h	4.0	8.4	11.0	22.6	19.0	36.2	37.0	62.0	83.0	139.0	
	60 Hz		4.8	10.1	13.2	27.1	22.8	43.4	44.4	74.4	99.6	166.8	
Max. supply pressure		bar	12	16	12	16	12	16	10		5		
Max. stroke frequency	50 Hz	RPM	26		72		120		72	120	72	120	
	60 Hz		31.2	31.2	86.4	86.4	144.0	144.0	86.4	144.0	86.4	144.0	
Suction head for non-gassing media		mWS	9						8		7		
Max. supply pressure		mbar	500										
Stroke length		mm	7.5						10.0				
Nominal valve width			DN4						DN6		DN10		
Voltage supply			230 / 400 V (optional 115 V)										
Protection class			IP 55										
Insulation class			F										
Weight*	PVC	kg	4.5						5.9				
	PP		4.5						5.9				
	PVDF		4.8						7.5				
	1.4571		6.0						11.2				
Max. ambient temperature		°C	45 (40 with PVC parts)										
Max. temperature of the medium		°C	80 (with PVC parts 35; with PP parts 60)										

MEMDOS LB			110	160	210	260	310	400	510	760	1010	
Delivery capacity at max. pressure	50 Hz	l/h	111	154	219	274	319	398	544	773	1088	
	60 Hz		133.2	184.8	262.8	328.8	382.8	477.6	652.8	927.6	1305.6	
Max. supply pressure		bar	10		8		6		5		4	
Max. stroke frequency	50 Hz	RPM	96	120	96	120	96	120	53	76	107	
	60 Hz		115.2	144.0	115.2	144.0	115.2	144.0	63.6	91.2	128.4	
Suction head for non-gassing media		mWS	7.0		6.0		4.5		1.0			
Max. supply pressure		mbar	500									
Stroke length		mm	10.0						12.5			
Nominal valve width			DN10		DN15				DN25			
Voltage supply			230 / 400 V (optional 115 V)									
Protection class			IP 55									
Insulation class			F									
Weight*	PVC	kg	9.0		9.8		11.5		13.6			
	PP		9.0		9.8		11.5		13.6			
	PVDF		9.6		10.7		13.0		16.2			
	1.4571		14.3		17.4		23.2		36.0			
Max. ambient temperature		°C	45 (40 with PVC parts)									
Max. temperature of the medium		°C	80 (with PVC parts, 35; with PP parts 60)									

*) Without a motor

Delivery characteristic curves

The delivery characteristic curves are valid for 20 °C (68 F) for water at 100% stroke frequency. The delivery capacity depends on the medium (density and viscosity) and temperature. Dosing pumps must therefore be gauged in litres during application.

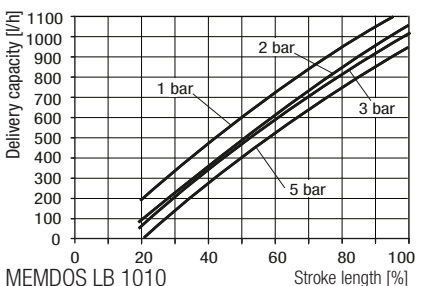
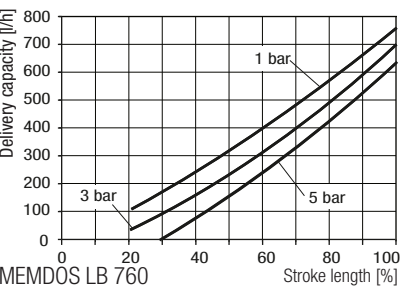
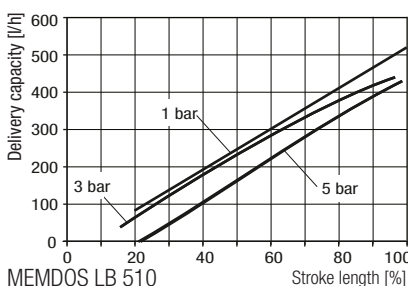
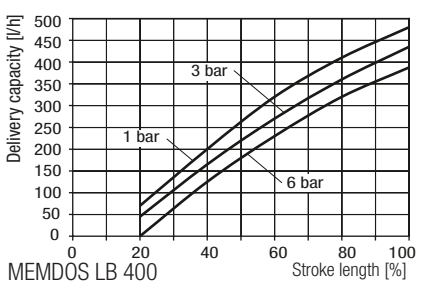
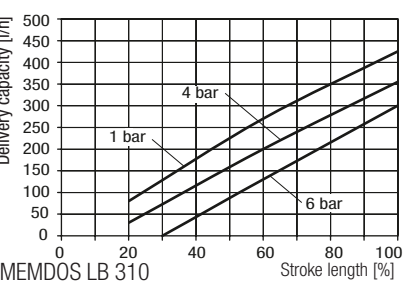
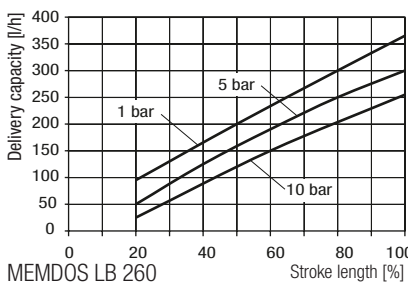
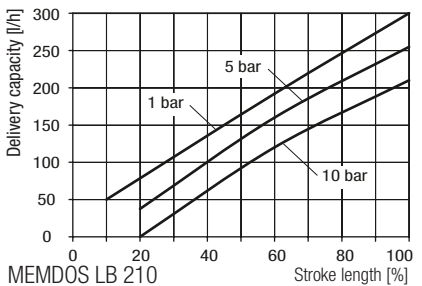
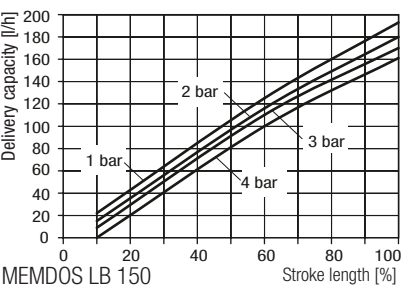
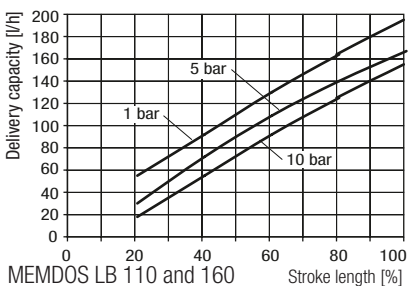
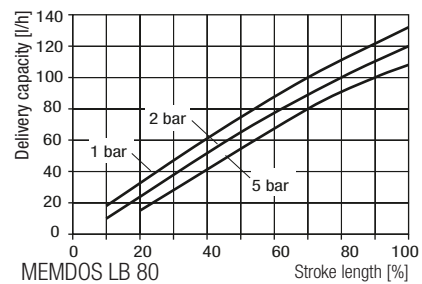
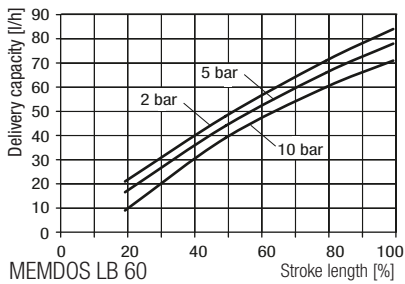
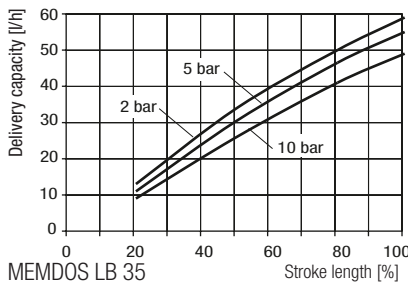
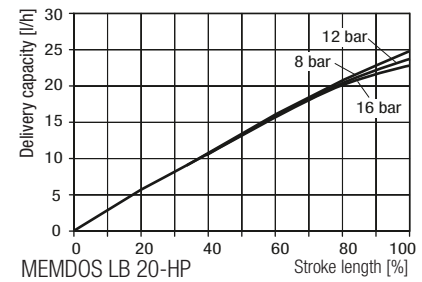
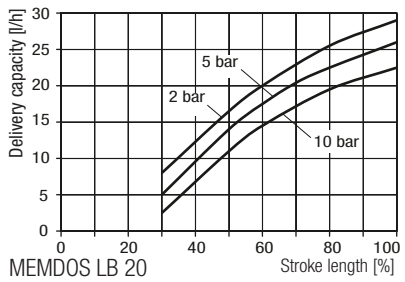
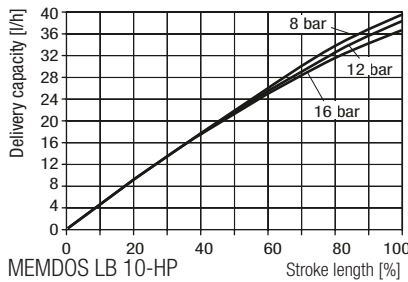
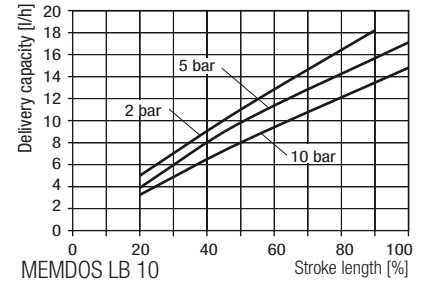
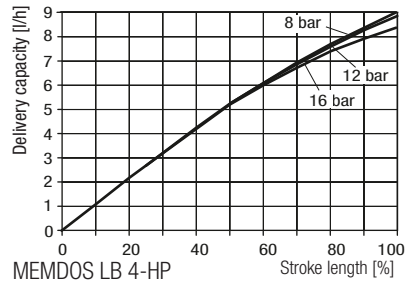
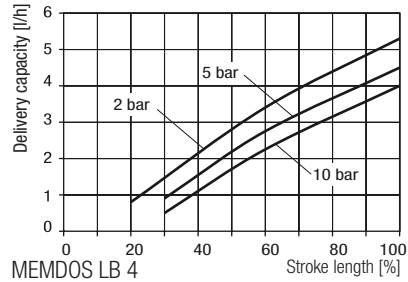

Product Information Motor-driven Diaphragm Dosing Pump MEMDOS LB

Dimensions

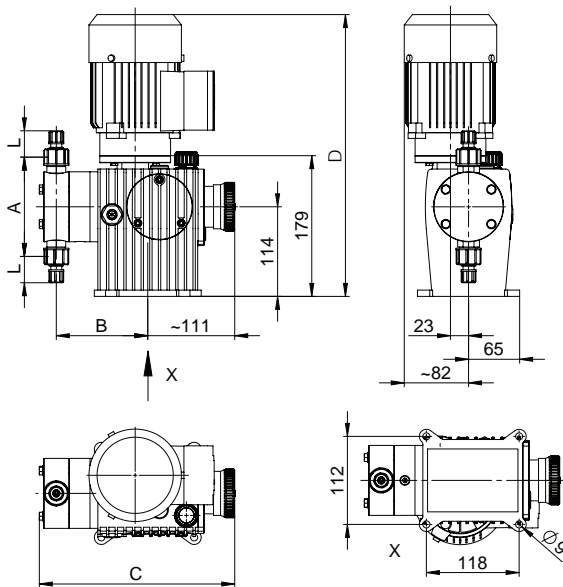

MEMDOS LB 4 - 80 and 150

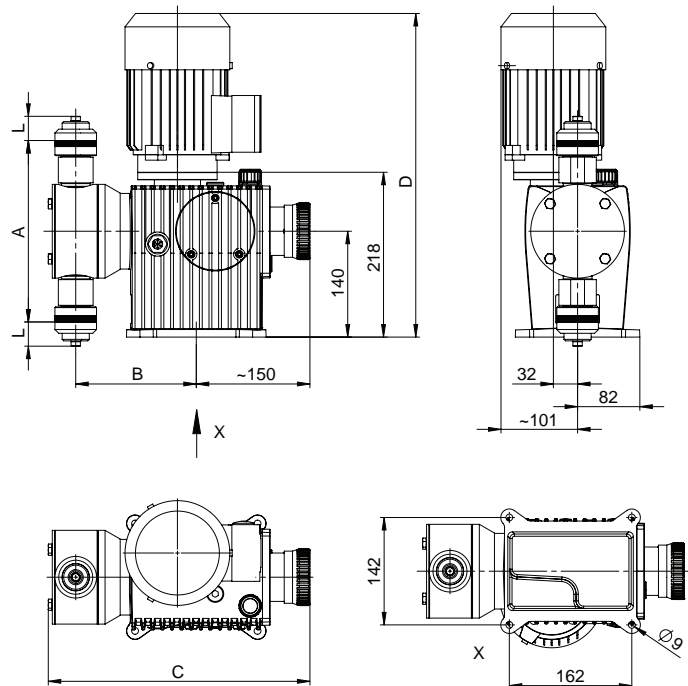

MEMDOS LB 110, 160 - 1010

Size	4 - 20	35 - 60	80, 150	110, 160	210 - 260	310 - 400	510 - 1010
A	126	149	249	240	268	312.5	352
B	116	121.5	133	160	170	175	185
C	249	256	280	346	357	362	387
D (standard motor)	389	389	389	437	437	437	450
L	Depends on the connection type and size						

All dimensions in mm

Accessories

Suitable sets of accessories, which consists of a suction line, a pressure line and an injection nozzle, are available for the dosing pumps.

Even the best pump can still be improved - namely by the right technical periphery. To make your dosing pump into an efficient dosing system, we recommend using the following accessories:

- Injection nozzles – to dose the medium in the main line and to prevent it flowing back into the pressure line
- Pressure loading and relief valves – to increase dosing accuracy or to protect the system against too high a pressure
- Pulsation dampener – to damp supply currents as well as to reduce the flow resistance in long pipelines.

- Priming aids – to significantly ease priming of dosing pumps with low supply volumes per stroke, for large suction heights, for highly-viscous dosing media or for initial priming or when priming after the system has been laying idle
- Suction pressure regulator – to prevent medium flow when the dosing pump is not running or to prevent a vacuum being formed in the event of a pipe burst

For further accessories for your dosing pump, please refer to our dosing pump brochure.